



Marine Grade SS 316
Rust free for life time



Luxurious Architectural Drain System



Roof Drain



Paropet Scupper Drain

Catalogue cum Price List
wef. 01/4/2022

COMPANY PROFILE



we are nothing without you

Drainage | Bath Accessories | Logistics | Advertising

The Business Details

Company Name : Winner Group of Companies

Established date : 1998

Website URL : winnergroup.in

Email address: : companies@winnergroup.in | customercare@winnergroup.in | winnergroun2510@gmail.com

Description of the business including the mission and vision

The winner group of companies started its most humble beginning in 1998 at Mumbai with the aim to excel in the field of bathroom accessories and drainage systems. As a brand it has expanded itself in the country since then by sheer means of its quality and service. The company which start with the honest efforts of a small team is a giant player in the field today with branches in more than 12 states I the country and still counting, thanks to the tireless efforts and dedication of the vastly experienced team along with unmatched quality of the Winner.

The winner group of companies is committed to its customers and has a single oriented mission top quality bathroom accessories and drainage systems. The products are launched with utmost care keeping in view and practical aspects and details study on place to place basis. It simply results in production of best suited and adopted products as per geographical & topographical conditions of various states which results in the production of most adopted products for the particular region and ensures the longest possible life of the product. Winner group of companies is also committed to very concept of make in India wherein all our products are completely mad and assembled in our beloved country.

Product description.

The company has a vast range of bathroom brass accessories and drainage system (316 products) which keeps on adding to keep itself updated to present customer and market requirements. The details of the same are given in the catalogue of the company.

Description of services

The services of the company are a complete package to include market survey, Research, production, marketing, advertising and after sale services. This is supported by separate and dedicated public relations branch of the company. The company has a vast public profile thanks to the dedicated efforts of the team winner. The platforms on the social media and internet services are vastly used by the company to improve and maintain its public profile.

Advertising

Special emphasis is being given on the very important of introducing winner to public and market by means of intelligent advertising which ensures that we convey ourselves to the market and reach to our customers in the most humble manner. Pamphlet, Newspaper, social media and web services are the most advertising platforms presently utilised by company. We dedicated a constant % of our annual turnover on the important aspect of advertising.

All Copyrights written by Mr. Kamlesh

Team



CUSTOMIZED SERVICE



Marine Grade Stainless Steel 316L / 304

Product Code :

Description : Manhole cover / Parking channel / Ductile iron available in customized sizes

Load class : Available in En1499 Norms upto A15 (1.5 Ton) To F900 (90 Ton)

Material : SS-304, SS-316, MS & CASTING

Available Sizes: In all size as per the Houshold & Commercial requirement in (SS-304, SS-316, MS & Casting.)

Note : We provide high quality product with highly advanced manufacturing technology of ductile iron, galvanised iron & HDPE channel in ultra modern plant.

Some product's sample given below:



Product : Casting

Load : 1 to 90 ton



Product : Parking Channel / Galvanised/HDPE/Casting

Load : 1 to 90 ton

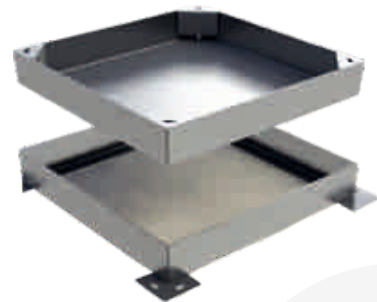

Product : Manhole Cover

MS, SS-304, SS-316

Load : 1 to 90 ton

We intruduce **JOINT FREE** shower drain in India in various architecturel design given below:

Size - 600mmx70mmx17mm Outlet-50mm.
Minimum quantity required for the above product
MRP: Rs. 3201/-





Winner Linear Shower Drain



Winner Tile/Marble Shower Drain

Marine Grade Stainless Steel 316L / 304

This type of Shower drain Channel blends in seamlessly with floor tiles, hence the name 'invisible'. It is perfectly suited for modern, luxury bathrooms where aesthetics and efficiency of drainage are of vital importance to the design. The invisible Shower Channel solution is available in Six different sizes, as shown in the table below the image (see table).

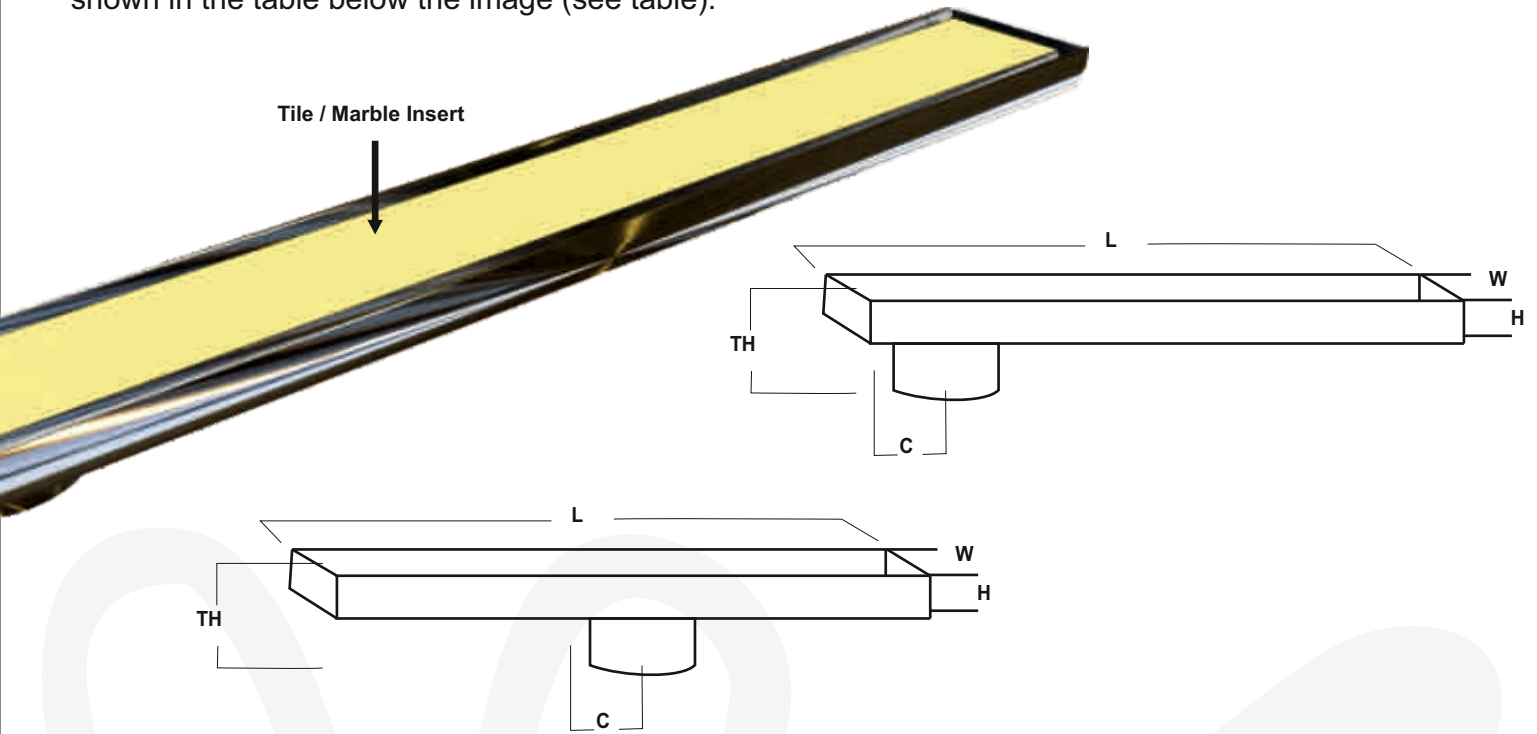

Tile Insert Shower Drain Channels : Available Sizes

Article No.	SS 316 MRP	Article No.	Size mm (L x W x H)	Outlet mm	Thickness in mm	SS 304 MRP	Outlet	Outlet
W-001	5493	WIN-11111	300 x 70 x 25	50	1	4193	Centre	Side
W-002	7895	WIN-11112	450 x 70 x 25	50	1	6027	Centre	Side
W-003	9302	WIN-11113	600 x 70 x 25	50	1	7102	Centre	Side
W-004	10487	WIN-11114	700 x 70 x 25	50	1	8005	Centre	Side
W-005	11586	WIN-11115	800 x 70 x 25	50	1	8844	Centre	Side
W-006	12735	WIN-11116	900 x 70 x 25	50	1	9722	Centre	Side
W-007	14073	WIN-11117	1000 x 100 x 25	50	1	10743	Centre	Side
W-008	18020	WIN-11118	1200 x 100 x 25	50	1	13756	Centre	Side
W-009		WIN-11119	1500 x 100 x 25	50	1		Centre	Side
W-010		WIN-11120	1800 x 100 x 25	50	1		Centre	Side

Marble Drain Channels rates are different*

Winner Tile/Marble Shower Drain



Marine Grade Stainless Steel 316L / 304

This type of Shower drain Channel blends in seamlessly with floor tiles, hence the name 'invisible'. It is perfectly suited for modern, luxury bathrooms where aesthetics and efficiency of drainage are of vital importance to the design. The invisible Shower Channel solution is available in Six different sizes, as shown in the table below the image (see table).



Tile Insert Shower Drain Channels : Available Sizes

Article No.	SS 316 MRP	Article No.	Size mm (L x W x H)	Outlet mm	Thickness in mm	SS 304 MRP	Outlet	Outlet
W-011	6505	WIN-11121	300 x 100 x 22	75	1	4966	Centre	Side
W-012	8241	WIN-11122	450 x 100 x 22	75	1	6289	Centre	Side
W-012		WIN-11122A	450 x 84 x 22	50	1	4717		Side
W-013	9302	WIN-11123	600 x 100 x 22	75	1	7102	Centre	Side
W-014	11364	WIN-11124	700 x 100 x 22	75	1	8674	Centre	Side
W-015	11705	WIN-11125	800 x 100 x 22	75	1	8936	Centre	Side
W-016	12014	WIN-11126	900 x 100 x 22	75	1	9171	Centre	Side
W-017	13730	WIN-11127	1000 x 100 x 22	75	1	10481	Centre	Side
W-018	16647	WIN-11128	1200 x 100 x 22	75	1	12708	Centre	Side
W-019		WIN-11129	1500 x 100 x 22	75	1		Centre	Side
W-020		WIN-11130	1800 x 100 x 22	75	1		Centre	

Marble Drain Channels rates are different*



We are nothing without you

Winner Strip Shower Drain



This type of Shower Drain Channel is specifically designed to ensure a quick and effective drainage of water while maintaining the aesthetics of the floor design. With its rectangular-shaped, strip-patterened grating and its non-magnetic and anti corrosion properties (316), this is one of the most sought-after designs in this segment. The Invisible Shower Drain Channel solution is available in Six different sizes, as shown in the table below the image

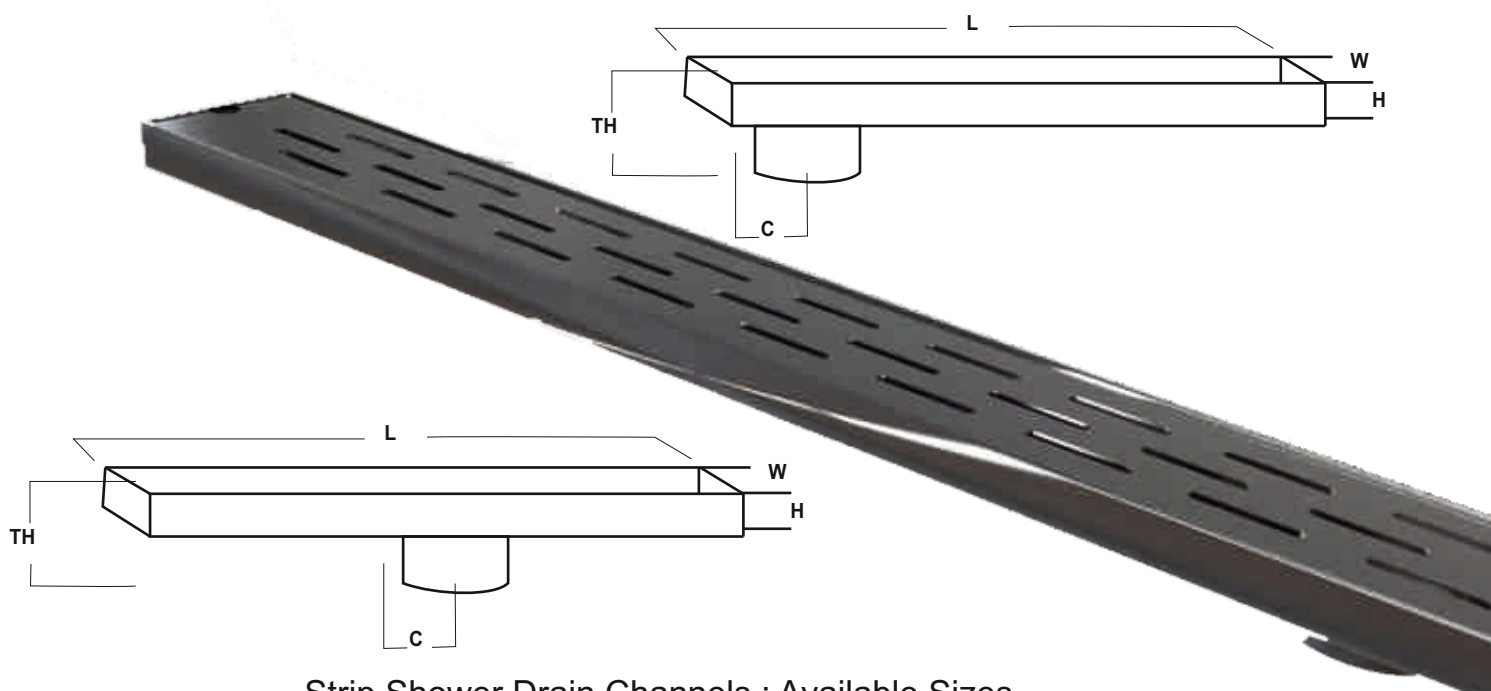

Strip Shower Drain Channels : Available Sizes

Article No.	SS 316 MRP	Article No.	Size mm (L x W x H)	Outlet mm	Thickness in mm	SS 304 MRP	Outlet	Outlet
W-021	6505	WIN-11131	300 x 100 x 22	75	1	4966	Centre	Side
W-022	8254	WIN-11132	450 x 100 x 22	75	1	6302	Centre	Side
W-023	9647	WIN-11133	600 x 100 x 22	75	1	7364	Centre	Side
W-024	10298	WIN-11134	700 x 100 x 22	75	1	7861	Centre	Side
W-025	11431	WIN-11135	800 x 100 x 22	75	1	8726	Centre	Side
W-026	11997	WIN-11136	900 x 100 x 22	75	1	9158	Centre	Side
W-027	13594	S-WIN-01	1000 x 100 x 22	75	1	10377	Centre	Side
W-028	16854	S-WIN-02	1200 x 100 x 22	75	1	12866	Centre	Side
W-029		S-WIN-03	1500 x 100 x 22	75	1		Centre	Side
W-030		S-WIN-04	1800 x 100 x 22	75	1		Centre	Side

Thickness Variation is Possible as per Product*

The S - Style Shower Channel solution is available in Six different sizes, as shown in the table below the image (see table).

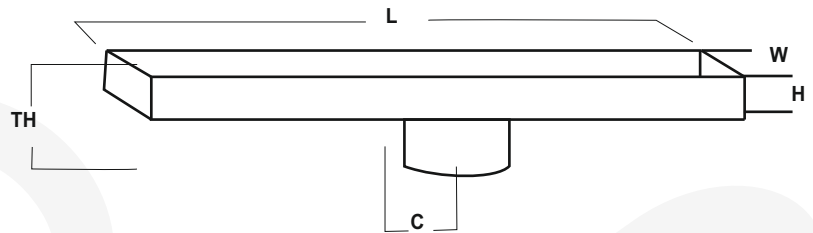
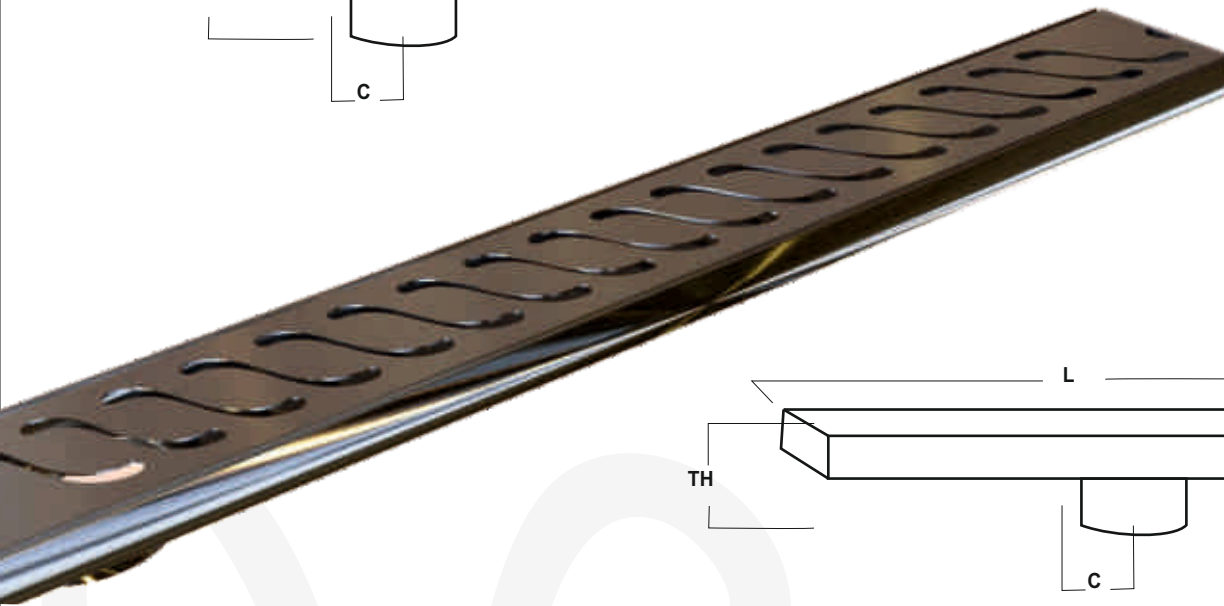
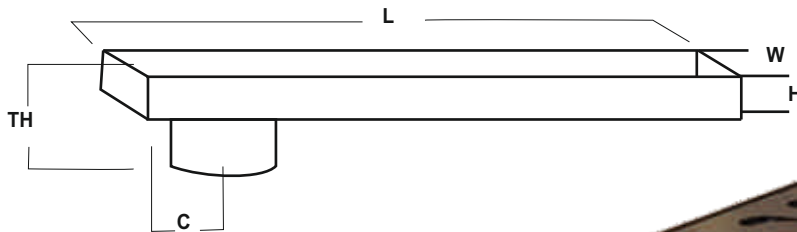

The Insert Shower Drain Channels : Available Sizes

Article No.	SS 316 MRP	Article No.	Size mm (L x W x H)	Outlet mm	Thickness in mm	SS 304 MRP	Outlet	Outlet
W-031	6540	WIN-11137	300 x 100 x 22	75	1	4992	Centre	Side
W-032	8256	WIN-11138	450 x 100 x 22	75	1	6302	Centre	Side
W-033	9526	WIN-11139	600 x 100 x 22	75	1	7272	Centre	Side
W-034	10281	WIN-11140	700 x 100 x 22	75	1	7848	Centre	Side
W-035	11535	WIN-11141	800 x 100 x 22	75	1	8805	Centre	Side
W-036	12529	WIN-11142	900 x 100 x 22	75	1	9564	Centre	Side
W-037	13730	WIN-11143	1000 x 100 x 22	75	1	10481	Centre	Side
W-038	17026	WIN-11144	1200 x 100 x 22	75	1	12997	Centre	Side
W-039		WIN-11145	1500 x 100 x 22	75	1		Centre	Side
W-040		WIN-11146	1800 x 100 x 22	75	1		Centre	Side
W-041	6386	WIN-11147	300 x 100 x 22	75	1	4875	Centre	Side

Thickness Variation is Possible as per Product*

Winner Line Shower Drain



Marine Grade Stainless Steel 316L / 304

This type of Shower Drain Channel is designed for customers who prefer check-patterned drainage utilities. Its check-patterned grating and non-magnetic, anti-corrosion properties (316L/304), It is a highly-preferred drainage solution for aesthetically conscious customers.

The Check Shower Channel solution is available in Six different sizes, as shown in the table below the image (see table).

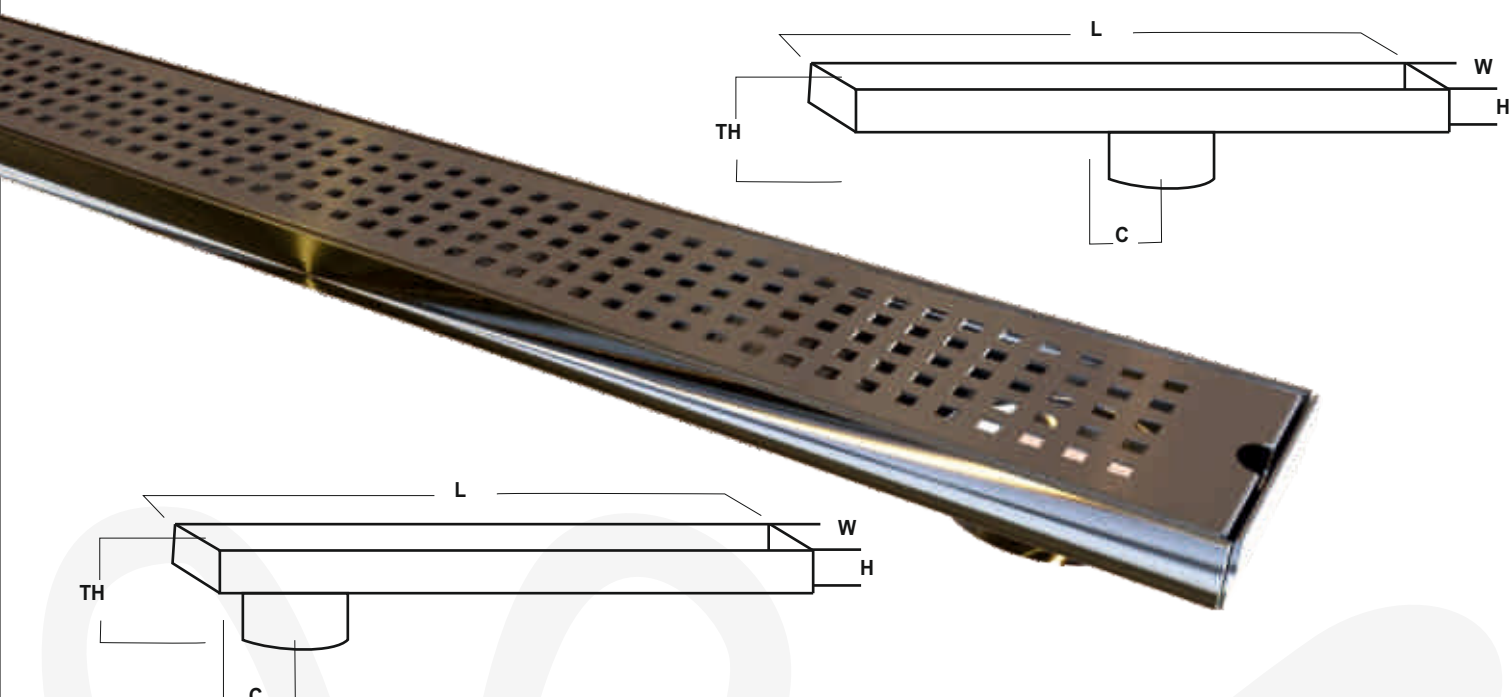

Tile Insert Shower Drain Channels : Available Sizes

Article No.	SS 316 MRP	Article No.	Size mm (L x W x H)	Outlet mm	Thickness in mm	SS 304 MRP	Outlet	Outlet
W-042	8241	WIN-11146	450 x 100 x 22	75	1	6289	Centre	Side
		WIN-11146	450 x 84 x 22	75	1	4717	Centre	Side
W-043	9302	WIN-11147	600 x 100 x 22	50	1	7102		Side
W-044	9990	WIN-11148	700 x 100 x 22	75	1	7626	Centre	Side
W-045	11363	WIN-11149	800 x 100 x 22	75	1	8674	Centre	Side
W-046	12357	WIN-11150	900 x 100 x 22	75	1	9433	Centre	Side
W-047	13594	WIN-11151	1000 x 100 x 22	75	1	10377	Centre	Side
W-048	16683	WIN-11152	1200 x 100 x 22	75	1	12735	Centre	Side
W-049	0	WIN-11153	1500 x 100 x 22	75	1		Centre	Side
W-050	0	WIN-11154	1800 x 100 x 22	75	1		Centre	Side
W-PP-51	3027		150 x 150MM Glossy		1		Centre	

Thickness Variation is Possible as per Product*



TILE / MARBLE INSERT



Tiles / Marble Insert

Winner Tile / Marble Drain

Marine Grade Stainless Steel 316L / 304



WIN 11155 WIN 11156
125X125mm 150X150mm

Tile Insert with Anti Cockrach Trap

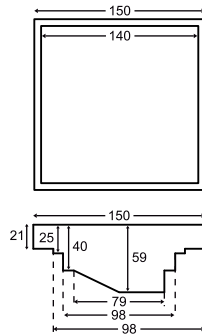

WIN 11159 WIN 11160
125X125mm 150X150mm

Tile Insert without Anti Cockrach Trap

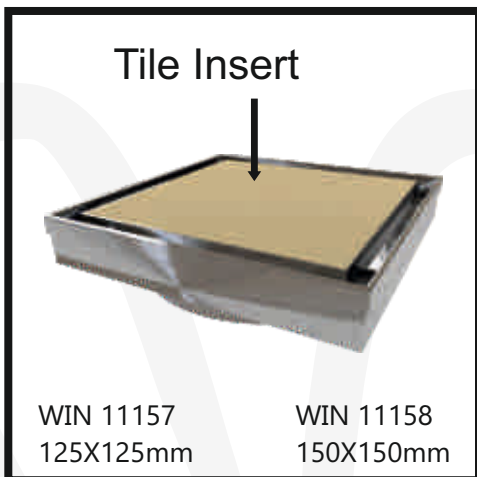

Tile Insert

WIN 11157 WIN 11158
125X125mm 150X150mm

**Tile Insert with Anti Cockrach Trap
Grade Stainless Steel 304/316**

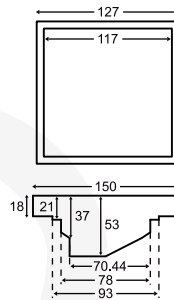

Marbal Insert

WIN 11161 WIN 11162
125X125mm 150X150mm

**Marbal Insert with Anti Cockrach Trap
Grade Stainless Steel 304/316**

Code	Overall Size	Outlet	Tile / Depth mm	Tile Insert SS 316 MRP	Marble Insert SS 304 MRP
WIN - 11155	125 x 125	72 MM	11	----	2032
WIN - 11156	150 x 150	97 MM	11	----	2490
WIN - 11157	125 x 125	97 MM	12	2922	2412
WIN - 11158	150 x 150	97 MM	12	3132	2779
WIN - 11159	125 x 125	72 MM	11	----	1757
WIN - 11160	150 x 150	97 MM	11	----	2228
WIN - 11161	125 x 125	97 MM	19	3591	3211
WIN - 11162	150 x 150	97 MM	19	3853	3473

All Anti Cockroach Traper are Grade SS 304 only*

Winner Floor Drain

Marine Grade Stainless Steel 316L / 304



WIN 11163 125X125mm
WIN 11164 150X150mm

Floor Trap with/without Anti Cockrach Trap

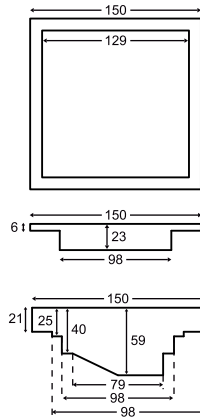

WIN 11167 125X125mm
WIN 11168 150X150mm

Floor Trap with/without Anti Cockrach Trap



WIN 11165 125X125mm
WIN 11166 150X150mm

Floor Trap with/without Anti Cockrach Trap

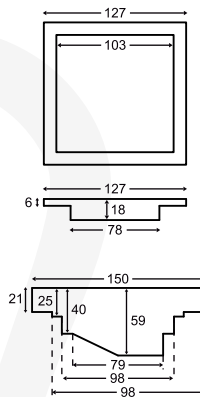

WIN 11169 125X125mm
WIN 11170 150X150mm

Floor Trap with/without Anti Cockrach Trap

Code	Overall Size	Upper / Lower Thickness	Floor Trap Without Anti Cockroach MRP	Floor Trap With Anti Cockroach MRP	
WIN - 11163	125 x 125	1.2 x 1 MM	683	1272	
WIN - 11164	150 x 150	1.2 x 1 MM	840	1338	
WIN - 11165	125 x 125	1.2 x 1 MM	696	1364	
WIN - 11166	150 x 150	1.2 x 1 MM	827	1416	
WIN - 11167	125 x 125	1.2 x 1 MM	683	1403	
WIN - 11168	150 x 150	1.2 x 1 MM	853	1403	
WIN - 11169	125 x 125	1.2 x 1 MM	696	1285	
WIN - 11170	150 x 150	1.2 x 1 MM	827	1351	

Thickness Variation is Possible as per Product*

Winner Floor Drain

Marine Grade Stainless Steel 316L / 304



WIN 11171 125X125mm
WIN 11172 150X150mm

Floor Trap with/without Anti Cockrach Trap

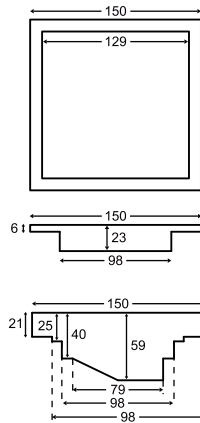

WIN 11175 125X125mm
WIN 11176 150X150mm

Floor Trap with/without Anti Cockrach Trap



WIN 11173 125X125mm
WIN 11174 150X150mm

Floor Trap with/without Anti Cockrach Trap

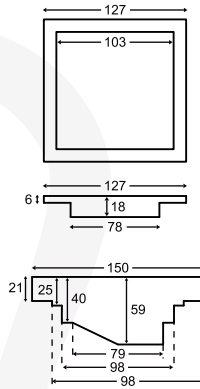

WIN 11177 125X125mm
WIN 11178 150X150mm

Floor Trap with/without Anti Cockrach Trap

Code	Overall Size	Upper / Lower Thickness	Without Trap MRP	With Trap MRP	
WIN - 11171	125 x 125	1.5 x 1 MM	748	1324	
WIN - 11172	150 x 150	1.5 x 1 MM	879	1377	
WIN - 11173	125 x 125	1.5 x 1 MM	656	1246	
WIN - 11174	150 x 150	1.5 x 1 MM	866	1311	
WIN - 11175	125 x 125	1.5 x 1 MM	669	1259	
WIN - 11176	150 x 150	1.5 x 1 MM	853	1324	
WIN - 11177	125 x 125	1.5 x 1 MM	709	1338	
WIN - 11178	150 x 150	1.5 x 1 MM	840	1390	

Thickness Variation is Possible as per Product*

Winner Cockroach Trapper

Marine Grade Stainless Steel 316L / 304

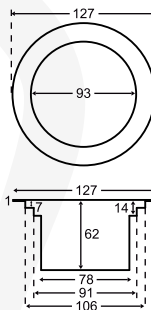
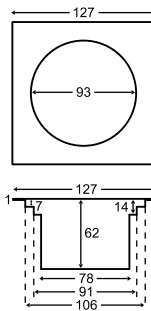
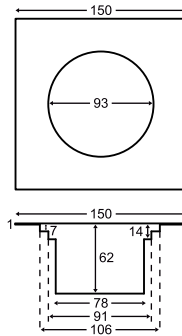

Usages - Bathroom, Kitchen, Hotel, Hospital, Industries and Corporate

Code	Overall Size	Thickness	Matt MRP	Glossy MRP	
WIN - 11179	127 x 127	1 MM	1062	1076	
WIN - 11180	150 x 150	1 MM	1102	1141	
WIN - 11181	127 x 127	1 MM	1089	1115	
WIN - 11182	150 x 150	1 MM	1010	1036	
WIN - 11183	127 x 127	1 MM	1089	1115	
WIN - 11184	150 x 150	1 MM	1089	1115	

Thickness variation is possible as per product



Winner Cockroach Grating

Marine Grade Stainless Steel 316L / 304



WIN 11185 127X127mm WIN 11186 150X150mm

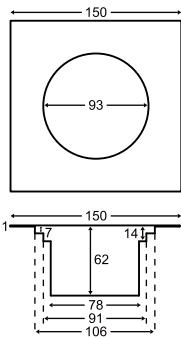

WIN 11188 127X127mm WIN 11189 150X150mm

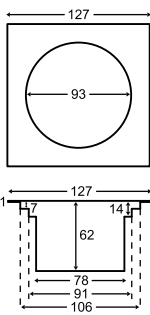

WIN 11187 127X127mm

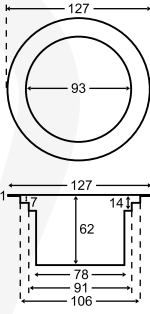

WIN 11190 127X127mm

Code	Overall Size	Thickness	Matt MRP	Glossy MRP	
WIN - 11185	127 x 127	1 MM	1010	1036	
WIN - 11186	150 x 150	1 MM	1089	1115	
WIN - 11187	127 x 127	1 MM	1089	1115	
WIN - 11188	127 x 127	1 MM	1049	1062	
WIN - 11189	150 x 150	1 MM	1089	1128	
WIN - 11190	127 x 127	1 MM	1049	1076	

Thickness variation is possible as per product

Winner Floor Drain

Marine Grade Stainless Steel 316L / 304



WIN 11191 127X127mm
WIN 11192 150X150mm

2 Pcs Curue Trap

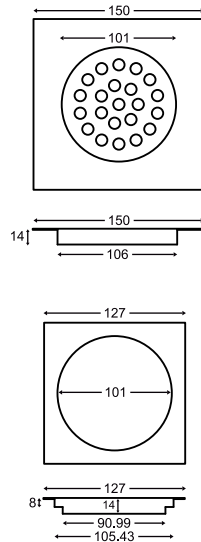

WIN 11194 127X127mm
WIN 11195 150X150mm

2 Pcs Lacking Trap



WIN 11193
127X127mm

2 Pcs Lacking Trap

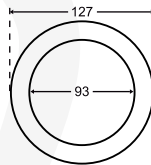

WIN 11196
127X127mm

2 Pcs Locking Trap

Code	Overall Size	Thickness	Matt MRP	Glossy MRP	
WIN - 11191	127 x 127	1 MM	578	591	
WIN - 11192	150 x 150	1 MM	643	656	
WIN - 11193	127 x 127	1 MM	565	591	
WIN - 11194	127 x 127	1 MM	565	591	
WIN - 11195	150 x 150	1 MM	630	669	
WIN - 11196	127 x 127	1 MM	578	604	
WIN - 11197	127 x 127	1 MM	578	604	
WIN - 11198	150 x 150	1 MM	617	643	

Thickness variation is possible as per product

Winner Floor Drain

Marine Grade Stainless Steel 316L / 304

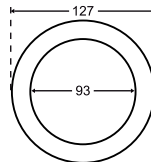
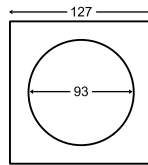
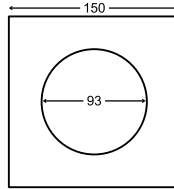

Anti Cockroach Trap



Plastic Anti Cockroach Trap

Code	Overall Size	Thickness	Matt MRP	Glossy MRP	Out Late
WIN - 11199	127 x 127	1 MM	682	682	
WIN - 11200	150 x 150	1 MM	787	787	
WIN - 11201	127 x 127	1 MM	577	630	
WIN - 11202	150 x 150	1 MM	604	643	
WIN - 11203	for 50mm Outlet	----	119		
WIN - 11204	for 75mm Outlet	----	159		
WIN - 11205	5" W/O hole Round Glossy	----	591		
WIN - 11206	5" hole Round Glossy	----	604		

Thickness variation is possible as per product

Cockroach Trap & Floor Drain



“WINNER” ECONOMICAL SERIES IN SS GRADE STAINLESS STEEL



WG-01
Round Plain 5" Heavy
Rs. 67/-
Packing 20 pcs



WG-02
Round Hole 5" Heavy
Rs. 80/-
Packing 20 pcs



WG-03
2 Pcs Round 5" Trap
Rs. 132/-
Packing 10 pcs



WG-04
2 Pcs Round with Hole
5" Locking Trap
Rs. 119/-
Packing 10 pcs



WIN 2143 W/Hole | WIN 2142 Hole
172/- | 250/-



WIN 2140 W/Hole | WIN 2138 Hole
159/- | 237/-



WIN 2146 W/Hole
329/-



WIN 2147 W/Hole
342/-

WIN 2141 W/Hole | WIN 2139 Hole
161/- | 161/-



WIN 2148 W/Hole | WIN 2149 Hole
360/- | 394/-



WIN 2150 W/Hole | WIN 2151 Hole
368/- | 407/-



SS Waste Coupling 3" & 5"
172/- | 211/-

SS-316 Self Slope Patent product by India's Luxury Brand



WIN-1144
AUTOSLOP TILE INSERT
Rs. 11000/-

ASMI-121
AUTOSLOP MARBLE TILE INSERT
Rs. 13000/-

Patent (AP No.) Design - 331498001



Winner Group of Companies

☎ : +91 8655498551 📞 +91 9022498551

✉ : companies@winnergroup.in
customer@winnergroup.in
winnergroup2510@gmail.com

🌐 : www.winnergroup.in



Terms & Condition: 1. The price are subject to change without prior notice
2. All disputes shall subject to Mumabi Jurisdiction only
3. Company reserve the right to alter orchange product design
or material in view of improvement without any notice